



InstantTrust

Tested. Trusted. Clean.

Clean water
you can rely on

PHILIPS

Certified InstantTrust technology disinfects water just before it's served

A range of tested and validated solutions

Philips InstantTrust is our new standard in the industry for disinfection solutions in drink/water dispensers, providing clean water in an instant, independent of water temperature. It is now certified to major water standards (see backpage). Already being designed-in by several OEMs, InstantTrust is available in a range of tested, validated solutions including inline and point-of-dispense versions.





Fit for purpose

InstantTrust solutions have been designed to make it easier for OEMs to integrate disinfection as close as possible to the dispensing outlet, disinfecting water just before it's served.

Whether you are designing dispensers with an in-line system mounted inside the purifier or a point-of-dispense system fitted outside the purifier, the major benefits of integrating InstantTrust into your equipment are:

- **Peace of mind:** has all the relevant approvals required for use in water purifiers
- **Design freedom and versatility:** very compact, so it can be built into systems with limited space. Can be used in gravity systems due to very limited pressure drop.
- **Energy efficient:** no power consumed when no water dispensed (helps to fulfill Energy Star requirements)
- **Simple controls:** easy on/off switch; easy to interact with control board of the purifier; electrical signal flags end of life or failure.
- **Temperature independent:** effective disinfection in cold or hot water applications

Why your customers will love it

InstantTrust switches on immediately when the water starts flowing and operates at full power within a fraction of a second to give instant disinfection. This ensures that the water is cleaned at the moment it is dispensed.

Here are some more reasons:

- **Freshness:** Cold water remains cold.
- **Worry-free:** InstantTrust is designed to disinfect 10,000 liters of water and will signal when it should be replaced.
- **Almost zero energy costs:** only switches on when water is flowing, so energy costs are around 40 cents for 10,000 liter! (calculated at 0.20 EUR kWh)
- **A sustainable choice:** contains no mercury, and fulfills ROHS requirements.
- **Reliable disinfection:** InstantTrust has been designed to exceed during its entire life the minimum required disinfection level as agreed with the customer. There is a stringent quality control during production to ensure that all products meet their requirements.

Extensively tested

InstantTrust has undergone extensive testing and microbiological validation. In the table below you will find the results from an external certified laboratory which measured the reduction of MS2 and E.coli species at different flow rates and water UVC transmissions.

Method	Log reduction	Flow [lpm]	System Power [W]
MS2, 70%/cm	2.4 / 2.3	2.5	27
MS2, 85%/cm	2.7 / 2.7	2.5	27
MS2, 85%/cm	2.0 / 2.0	4	27
MS2, 98%/cm	2.2 / 2.2	4	27
MS2, 100%/cm	3.4 / 3.6	2.5	27
E.coli, 98%/cm	6.8 / >6.8	4	27
E.coli, 85%/cm	4.6 / 4.6	4	27

Results of disinfection performance of InstantTrust technology.

In other labs, tests were performed on different microorganisms such as yeast, *Micrococcus lutea*, *K. terrigena*, *Brevundimonas diminuta*, *HPC* and *Pseudomonas Aeruginosa*. All results met customers' expectations and requirements.

Reliability is tested in extreme conditions during the design phase to ensure the lowest possible failure rate.

Disinfection performance is tested on a regular base during production in our in-house microbiological laboratory both at 0 hours and after reaching end of life.

A range of solutions to meet your needs

In-line solutions:

- 6-Pin connector or jack plug
- With or without cooling plate

Point-of-dispense solutions:

- Water dispensed directly out of InstantTrust

General specifications

- Input voltage: 9V DC
- System Power: 21 – 27W
- Water flow of up to 4 liter/minute
- Treatment capacity: 5000 liter up to 15000 liter of water depending on water quality, flow rate and required disinfection performance
- Different connections to water possible.

Certified for use in water treatment equipment

Philips InstantTrust (27W in-line solution) has been granted the following certifications:

- Compliance with applicable CE guidelines
- UL approved (electrical safety)
- Certificate of approval for materials in contact with drinking water, from:
 - National Institute of Public Health (Poland)
 - ACS (France)
 - KIWA (Netherlands)
 - Intertek (for WRAS requirements in UK)
- Microbiological performance has been verified at different flows and water qualities by a certified US laboratory.

In-line solution 27-30W

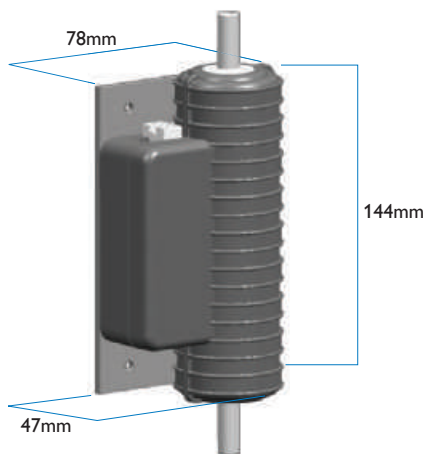

In-line solution 21-25W

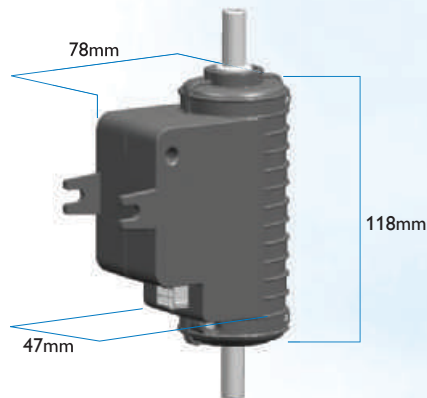

Point-of-dispense solution 21-25W

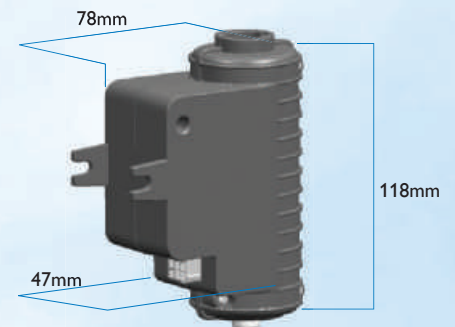

For more information,
visit www.philips.com/uvpurification



©2013 Koninklijke Philips N.V.
All rights reserved.