



MASTER LEDtube EM/ Mains

Master LEDTube 1200 mm 18W 865 T8 I W

The Philips MASTER LEDtube integrates a LED light source into a traditional fluorescent form factor. Its unique design creates a perfectly uniform visual appearance which cannot be distinguished from traditional fluorescent. For those that are looking for value for money within limited budget and re-lamping efforts for better light effect and lifetime.

Warnings and Safety

• -

Product data

General Information	
Cap base	G13 [Medium Bi-Pin Fluorescent]
EU RoHS compliant	Yes
Nominal lifetime (nom.)	40000 h
Switching cycle	50,000X

Light Technical	
Colour Code	865 [CCT of 6,500 K]
Beam Angle (Nom)	160 °
Luminous flux (nom.)	2100 lm
Colour designation	Cool Daylight
Correlated Colour Temperature (Nom)	6500 K
Luminous efficacy (rated) (nom.)	116.67 lm/W
Colour consistency	<6
Colour rendering index (nom.)	82
LLMF at end of nominal lifetime (nom.)	70 %

Operating and Electrical	
Input frequency	50 to 60 Hz
Power (Rated) (Nom)	18 W
Starting time (nom.)	0.5 s
Warm-up time to 60% light (nom.)	instant full light s
Power factor (nom.)	0.92
Voltage (Nom)	100-240 V

Temperature	
T-ambient (max.)	45 °C
T-ambient (min.)	-20 °C
T storage (max.)	65 °C
T storage (min.)	-40 °C
T-Case maximum (nom.)	70 °C

MASTER LEDtube EM/Mains

Controls and Dimming

Dimmable	No
----------	----

Mechanical and Housing

Product length	1200 mm
----------------	---------

Approval and Application

Energy efficiency label (EEL)	A+
Energy-saving product	Yes
Suitable for accent lighting	No
Approval marks	CE marking RoHS compliance KEMA Keur certificate
Energy consumption kWh/1,000 hours	18 kWh

Product Data

Full product code	871869652406000
Order product name	Master LEDTube 1200 mm 18W 865 T8 I W
EAN/UPC – product	8718696524060
Order code	52406000
Numerator – quantity per pack	1
Numerator – packs per outer box	10
SAP material	929001187812
SAP net weight (piece)	0.230 kg

Dimensional drawing

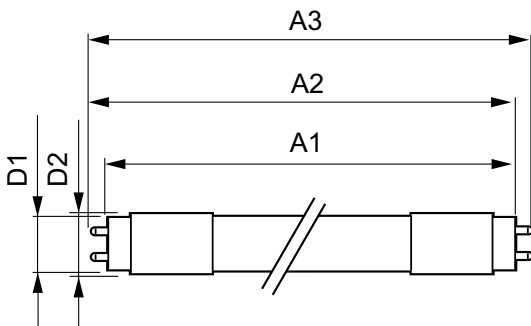

LEDtube 1200mm 18W/865 T8 I W

Product	D1	D2	A1	A2	A3
Master LEDTube 1200 mm 18W 865 T8 I W	25.6 mm	27.8 mm	1198.1 mm	1205.2 mm	1212.3 mm

Photometric data

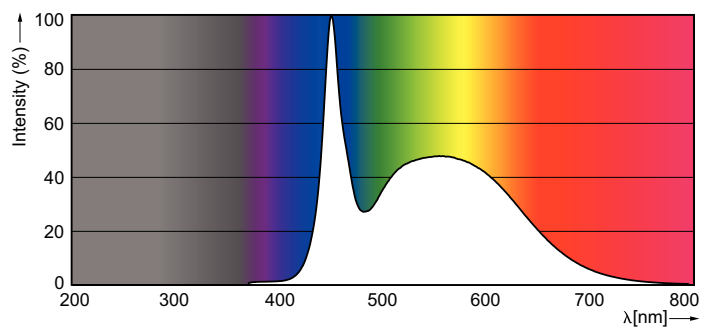
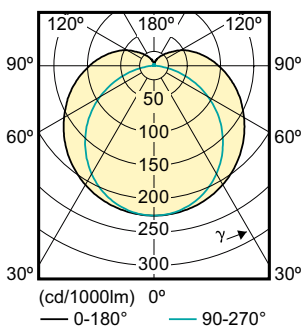

SDPO_MLEDGA_0069-Spectral Power distribution

MASTER LEDtube EM/Mains

Lifetime

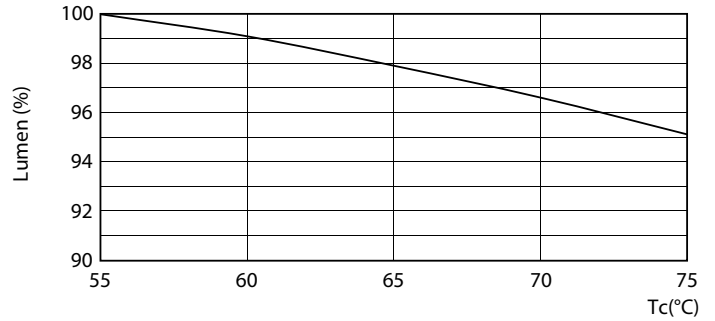
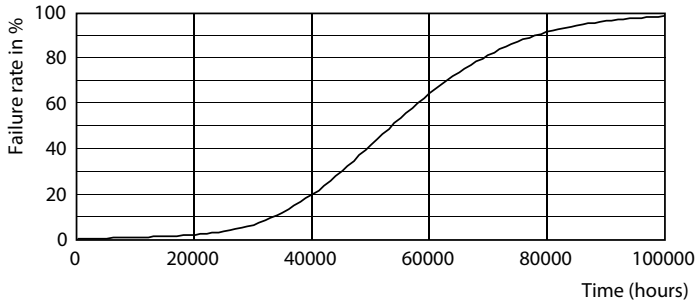

LEDTube 1200 mm 18W 840 T8 I W

LEDTube 1200 mm 18W 840 T8 I W LumenVsTc

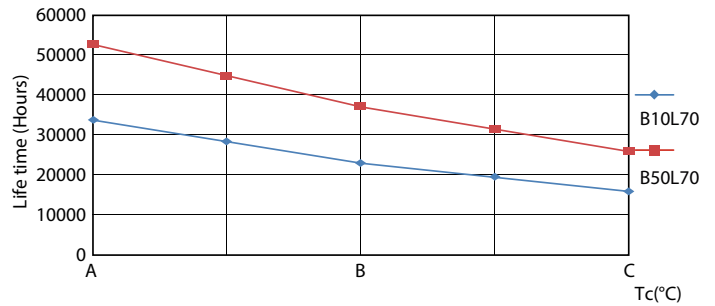
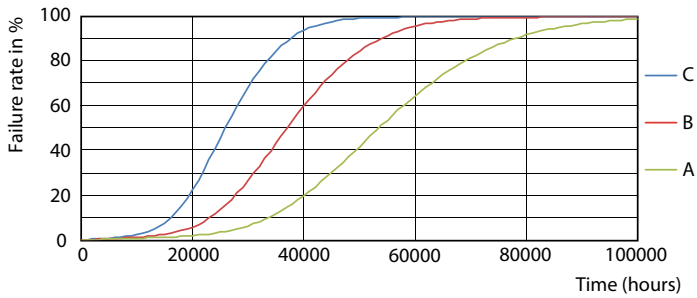

LEDTube 1200 mm 18W 840 T8 I W FailureRate

LEDTube 1200 mm 18W 840 T8 I W LifetimeVsTc

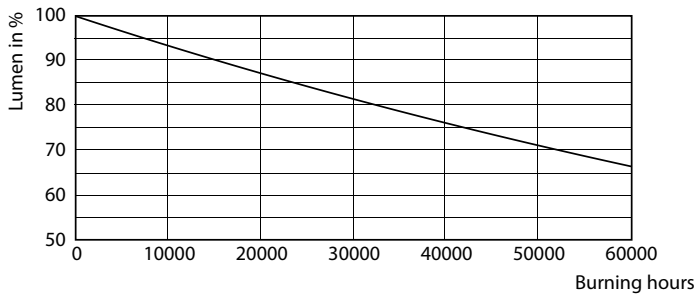

LEDTube 1200 mm 18W 840 T8 I W

MASTER LEDtube EM/Mains

