



MASTER LEDspot LV AR111

MAS LEDspotLV D 11-50W 930 AR111 40D

Delivering a warm, halogen-like accent beam, MASTER LEDspot LV AR111 is an ideal retrofit solution for spot and general lighting applications in the hospitality and retail industry. It is particularly suitable for general lighting where the light is on all the time, such as creative accent lighting applications in shops, restaurants, hotels, and especially for galleries, exhibitions and museums. The robustly designed MASTER LEDspot LV AR111 offers various beam angles for a clearly defined beam spread. There is no UV or IR in the beam, making it suitable for illuminating heat-sensitive objects (food, organic materials, paintings, etc.). The patented intelligent driver enables broad compatibility with existing electromagnetic and electronic halogen transformers. MASTER LEDspot LV AR111 delivers huge energy savings and minimizes maintenance cost without any reduction in brightness.

Product data

General Information	
Cap base	G53 [G53]
EU RoHS compliant	Yes
Nominal lifetime (nom.)	40000 h
Switching cycle	50,000X
Technical type	11-50W
Light Technical	
Colour Code	930 [CCT of 3,000 K]
Beam Angle (Nom)	40 °
Luminous flux (nom.)	640 lm
Luminous intensity (nom.)	1150 cd
Colour designation	White (WH)
Correlated Colour Temperature (Nom)	3000 K

Luminous efficacy (rated) (nom.)	58.18 lm/W
Colour consistency	<6
Colour rendering index (nom.)	90
LLMF at end of nominal lifetime (nom.)	70 %
Luminous flux in 90° cone (rated)	570 lm
Operating and Electrical	
Input frequency	- Hz
Power (Rated) (Nom)	11 W
Lamp current (nom.)	1300 mA
Wattage equivalent	50 W
Starting time (nom.)	0.5 s
Warm-up time to 60% light (nom.)	instant full light
Power factor (nom.)	0.7

MASTER LEDspot LV AR111

Voltage (Nom)	12 V
Temperature	
T-Case maximum (nom.)	70 °C
Controls and Dimming	
Dimmable	Yes
Approval and Application	
Energy efficiency label (EEL)	A
Suitable for accent lighting	Yes
Energy consumption kWh/1,000 hours	13 kWh

Product Data	
Full product code	871869651514300
Order product name	MAS LEDspotLV D 11-50W 930 AR111 40D
EAN/UPC – product	8718696515143
Order code	51514300
SAP numerator – quantity per pack	1
Numerator – packs per outer box	6
SAP material	929001170108
SAP net weight (piece)	0.360 kg

Dimensional drawing

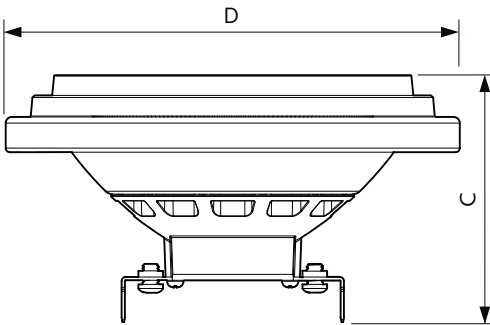

LED D 11-50W 930 AR111 40D

Product	D	C
MAS LEDspotLV D 11-50W 930 AR111 40D	111 mm	62 mm

Photometric data

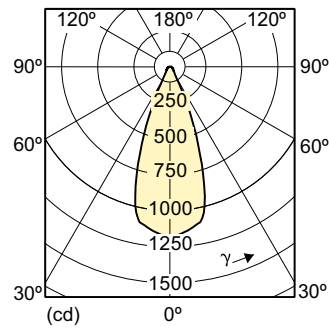
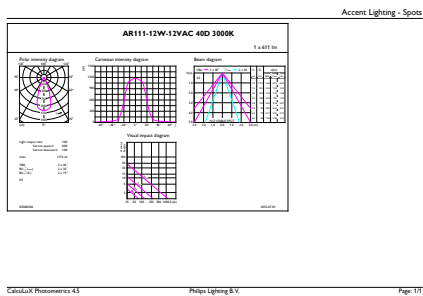

MASTER LEDspot LV AR111 50W G53 930 40D

MASTER LEDspot LV AR111

Photometric data

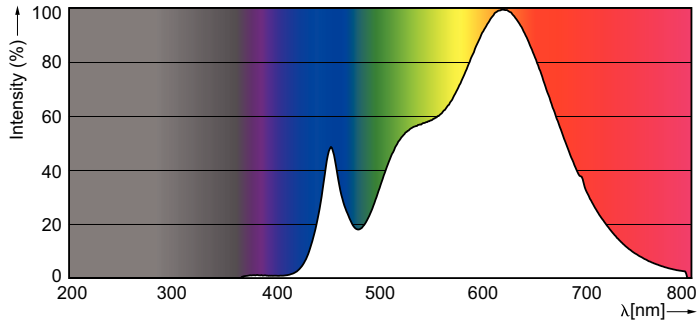

SDPO_LEDspotL_0026-Spectral Power distribution

Lifetime



MASTER LEDspotLV AR111 75W G53 940 40D



MASTER LEDspotLV AR111 75W G53 940 40D

