



Dynalite Relay Controllers

DDRC-GRMS

Hotel Room Controller

Hotel Room Controller

Product data

General Information	
CE mark	CE mark
Remarks	Please download the Lighting - Product Data Sheet for more information and ordering options
EU RoHS compliant	Yes
Application Conditions	
Ambient temperature range	0 to +40 °C
Product Data	
Full product code	871869688656400

Order product name	DDRC-GRMS
EAN/UPC – product	8718696886564
Order code	88656400
SAP numerator – quantity per pack	1
Numerator – packs per outer box	1
SAP material	913703667709
SAP net weight (piece)	0.560 kg

Dynalite Relay Controllers

Dimensional drawing

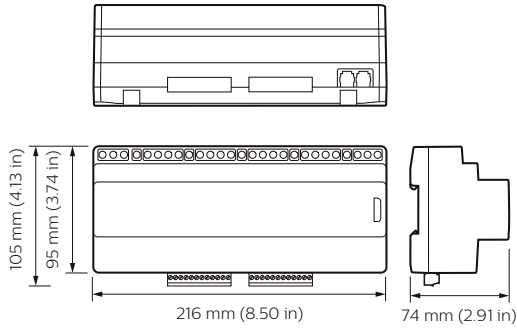

Dynalite Multipurpose Controllers

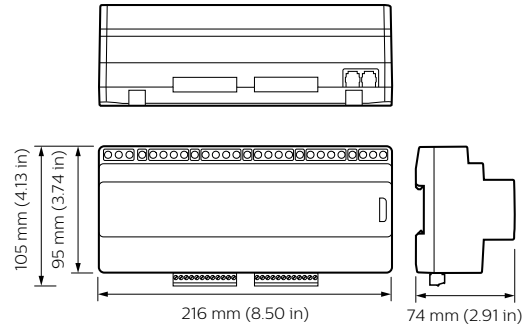

Dynalite Multipurpose Controllers

