



MASTER LEDspot ExpertColor LV

MASTER LED MR16 ExpertColor 7.2-50W 930 10D

MASTER LEDspot LV ExpertColor creates a warm and comfortable ambience for hospitality venues, homes and restaurants. It creates such an ambience with superior lighting that has a customised spectrum, high CRI and deep dimming feature. The result? A beautiful lighting experience. What's more, the innovative, trimless lens design will suit almost any interior decor with its clean and neat look. In addition, you can take advantage of the full ExpertColor family, which also includes LEDspot MV and LEDspot Par lamps.

Product data

General Information		LLMF at end of nominal lifetime (nom.) 70 %	
Cap base	GU5.3 [GU5.3]		
EU RoHS compliant	Yes	Operating and Electrical	
Nominal lifetime (nom.)	40000 h	Input frequency	- Hz
Switching cycle	50,000X	Power (Rated) (Nom)	7.2 W
Technical type	7.2-50W	Lamp current (nom.)	800 mA
Light Technical		Wattage equivalent	50 W
Colour Code	930 [CCT of 3,000 K]	Starting time (nom.)	0.5 s
Beam Angle (Nom)	10°	Warm-up time to 60% light (nom.)	1 s
Luminous flux (nom.)	480 lm	Power factor (nom.)	0.7
Luminous intensity (nom.)	5000 cd	Voltage (Nom)	12 V
Colour designation	White (WH)	Temperature	
Correlated Colour Temperature (Nom)	3000 K	T-Case maximum (nom.)	92 °C
Luminous efficacy (rated) (nom.)	66.67 lm/W	Controls and Dimming	
Colour consistency	<3	Dimmable	Yes
Colour rendering index (nom.)	97		

MASTER LEDspot ExpertColor LV

Mechanical and Housing

Bulb shape MR16 [2inch/50mm]

Approval and Application

Energy-saving product Yes

Suitable for accent lighting Yes

Energy consumption kWh/1,000 hours - kWh

Product Data

Full product code 871869657163700

Order product name	MASTER LED MR16 ExpertColor 7.2-50W 930 10D
EAN/UPC – product	8718696571637
Order code	57163700
SAP numerator – quantity per pack	1
Numerator – packs per outer box	10
SAP material	929001242008
SAP net weight (piece)	0.034 kg

Dimensional drawing

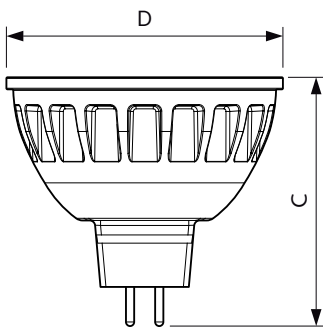

MR16 12V 7.2-50W 420lm 10D 3000K GU5.3 D

Product	D	C
MASTER LED MR16 ExpertColor 7.2-50W 930 10D	51 mm	46 mm

Photometric data

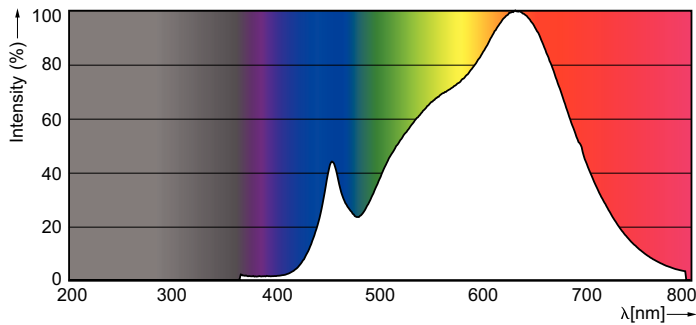

MAS LED ExpertColor 7.2-50W MR16 GU5.3 930

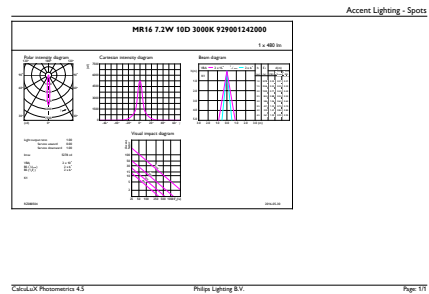

MAS LED ExpertColor 7.2-50W MR16 GU5.3 930 10D

MASTER LEDspot ExpertColor LV

Photometric data

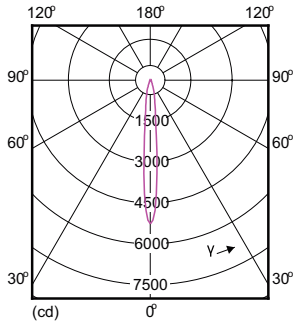

MAS LED ExpertColor 7.2-50W MR16 GU5.3 930 10D

