



CorePro LED PLC 2P

CorePro LED PLC 8.5W 840 2P G24d-3

The CorePro LED PLC 2P integrates a LED light source into a traditional fluorescent form factor. This product is the ideal solution for uplamping in general lighting applications: it meets basic lighting requirements, offers significant energy savings and is environmentally friendly.

Product data

General information		Lamp current (min.)	
Cap base	G24D-3 [G24d-3]		33 mA
EU RoHS compliant	Yes	Starting time (nom.)	0.5 s
Nominal lifetime (nom.)	30000 h	Warm-up time to 60% light (nom.)	0.5 s
Switching cycle	50000	Power factor (nom.)	0.9
	Sphere	Voltage (Nom)	220-240 V
Tier	CorePro	Temperature	
Light technical		T-ambient (max.)	35 °C
Colour Code	841 [CCT of 4100K (841)]	T-ambient (min.)	-20 °C
Beam Angle (Nom)	120 °	T storage (max.)	65 °C
Luminous flux (nom.)	1000 lm	T storage (min.)	-40 °C
Colour designation	Cool White (CW)	T-Case maximum (nom.)	75 °C
Correlated Colour Temperature (Nom)	4000 K	Controls and dimming	
Luminous efficacy (rated) (nom.)	105.88 lm/W	Dimmable	No
Colour consistency	<6	Mechanical and housing	
Colour rendering index (nom.)	83	Bulb material	Plastic
LLMF at end of nominal lifetime (nom.)	70 %	Product length	200 mm
Operating and electrical		Bulb shape	Tube, single-ended
Input frequency	50 to 60 Hz	Approval and application	
Power (Rated) (Nom)	8.5 W	Energy Efficiency Class	F
Lamp current (max.)	43 mA		

CorePro LED PLC 2P

Energy-saving product	Yes
Approval marks	TUV
Approval marks	CE marking RoHS compliance KEMA Keur certificate
Energy consumption kWh/1,000 hours	9 kWh
	403555
Product data	
Full product code	871869654125800
Order product name	CorePro LED PLC 8.5W 840 2P G24d-3

EAN/UPC – product	8718696541258
Order code	54125800
SAP numerator – quantity per pack	1
Local code description	CorePro LED PLC 8.5W 840 2P G24d-3
Numerator – packs per outer box	10
SAP material	929001201302
Net Weight (Piece)	0.090 kg

Dimensional drawing

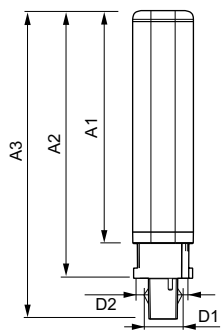

CorePro LED PLC 8.5W 840 2P G24d-3

Product	D1	D2	A1	A2	A3
CorePro LED PLC 8.5W 840 2P G24d-3	24.3 mm	28.4 mm	128.8 mm	148 mm	170.6 mm

Photometric data

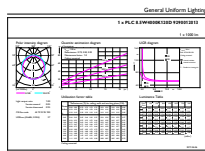

LEDtube PLC 100mm 9W G24D-3 840 1000lm

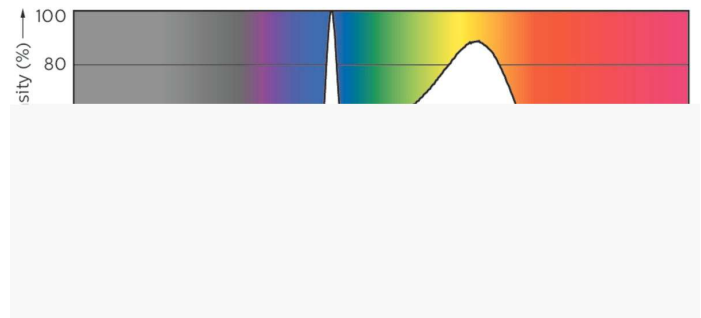

LEDtube PLC 100mm 9W G24Q-3 840 1000lm

CorePro LED PLC 2P

Photometric data

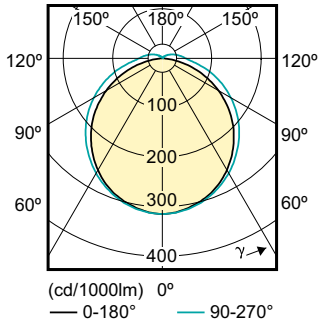

Lifetime

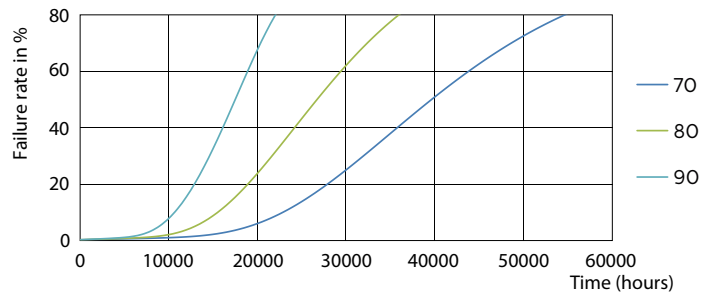
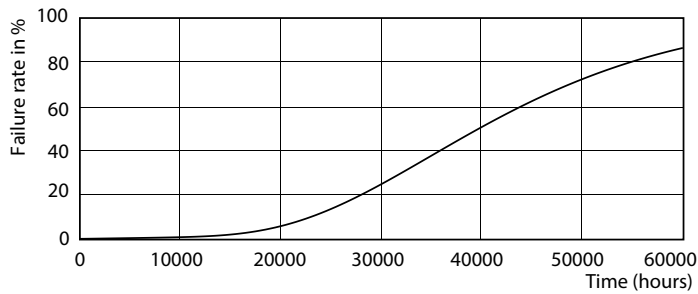

LEDtube PLC 100mm 9W G24D-3 830 950lm

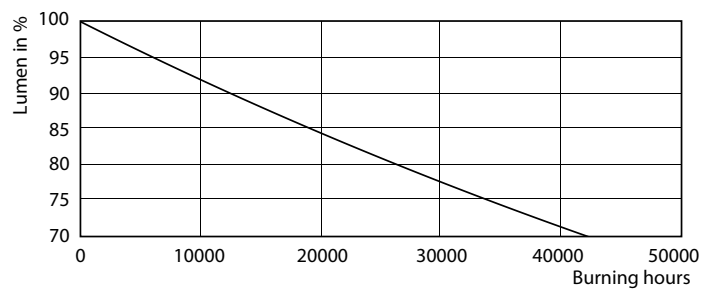

LEDtube PLC 100mm 9W G24D-3 830 950lm

CorePro LED PLC 2P

Lifetime

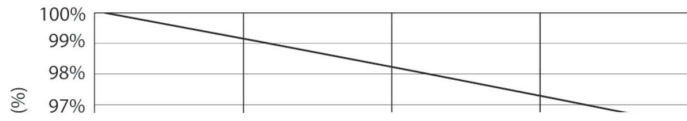

LEDtube PLC 100mm 9W G24D-3 830 950lm

