



Cabinet Controls

LLC7730/00 Coded Mains Receiver LN

LN receiver available to translate the Coded Mains dimming signal into DALI or 1 – 10 V.

LN receiver available to translate the Coded Mains dimming signal into DALI or 1 – 10 V.

Product data

Product data	
Full product code	871869672393700
Order product name	LLC7730/00 Coded Mains Receiver LN
EAN/UPC – product	8718696723937
Order code	72393700
SAP numerator – quantity per pack	1

Numerator – packs per outer box	60
SAP material	913713612080
Copy Net Weight (Piece)	0.075 kg

Dimensional drawing

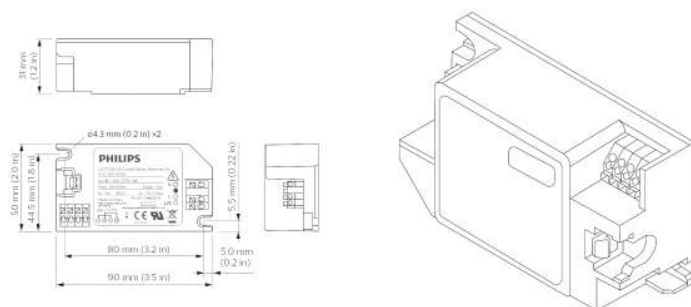

LLC7730/00 Coded Mains Receiver LN