



Dynalite Relay Controllers

DDRC420FR

4 channel Relay Controller for all types of switched loads up to 20A inductive.

4-channel relay controller for all types of switched loads up to 20 A inductive.

Product data

General Information	
CE mark	CE mark
Remarks	Please download the Lighting - Product Data Sheet for more information and ordering options
EU RoHS compliant	Yes
Application Conditions	
Ambient temperature range	0 to +50 °C
Product Data	
Full product code	871869688811700

Order product name	DDRC420FR
EAN/UPC – product	8718696888117
Order code	88811700
SAP numerator – quantity per pack	1
Numerator – packs per outer box	1
SAP material	913703244609
SAP net weight (piece)	329.000 g

Dynalite Relay Controllers

Dimensional drawing

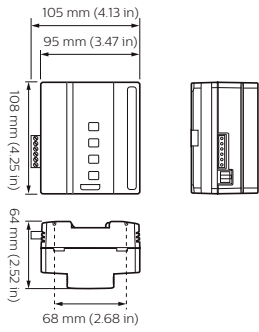

Dynalite Relay Controllers

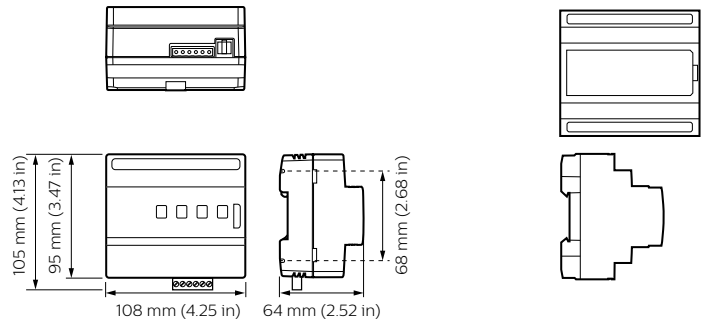

Dynalite Relay Controllers

