



Dynalite Network Accessories

DDNP1501

15 V DC 1.5 A regulated power supply to supplement the DyNet network DC supply.

15 V DC 1.5 A regulated power supply to supplement the DyNet network DC supply.

Product data

General Information	
CE mark	CE mark
Remarks	Please download the Lighting - Product Data Sheet for more information and ordering options
EU RoHS compliant	Yes
Application Conditions	
Ambient temperature range	0 to +40 °C
Product Data	
Full product code	871016350806100

Order product name	DDNP1501
EAN/UPC – product	8710163508061
Order code	50806100
SAP numerator – quantity per pack	1
Numerator – packs per outer box	1
SAP material	913703090309
SAP net weight (piece)	0.200 kg

Dynalite Network Accessories

Dimensional drawing

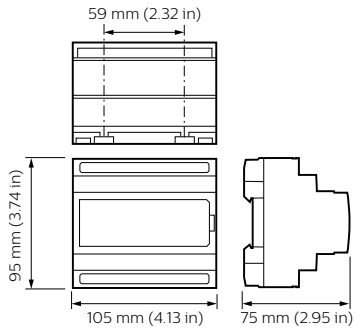

DDNP1501

