



Dynalite System Integration

DDNI-LON

Single point LON interface

Single point LON interface

Product data

General Information	
CE mark	CE mark
Remarks	Please download the Lighting - Product Data Sheet for more information and ordering options
EU RoHS compliant	Yes
Application Conditions	
Ambient temperature range	0 to +50 °C
Product Data	
Full product code	871016350790300

Order product name	DDNI-LON
EAN/UPC – product	8710163507903
Order code	50790300
SAP numerator – quantity per pack	1
Numerator – packs per outer box	1
SAP material	913703081409
SAP net weight (piece)	0.170 kg

Dynalite System Integration

Dimensional drawing

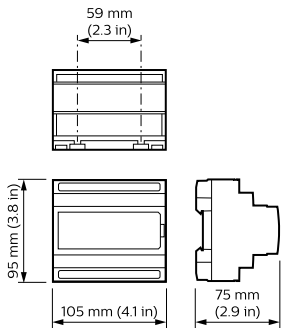

Dynalite System Integration

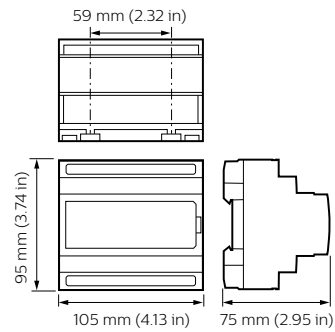

Dynalite System Integration

