



Dynalite Signal Dimmer Controllers

DBC1220GL

12 channels, max. load of 20A per channel and a total device load of 180A. For DALI, 1-10V and DSI.

12 channels, max. load of 20A per channel and a total device load of 180A. For DALI, 1-10V and DSI.

Product data

General Information	
CE mark	CE mark
Remarks	Please download the Lighting - Product Data Sheet for more information and ordering options
EU RoHS compliant	Yes
Application Conditions	
Ambient temperature range	0 to +50 °C
Product Data	
Full product code	871016350668500

Order product name	DBC1220GL
EAN/UPC – product	8710163506685
Order code	50668500
SAP numerator – quantity per pack	1
Numerator – packs per outer box	1
SAP material	913703038009
SAP net weight (piece)	7.000 kg

Dynalite Signal Dimmer Controllers

Dimensional drawing

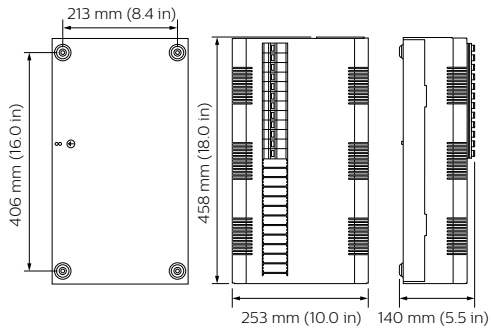

Dynalite Signal Dimmer Controllers

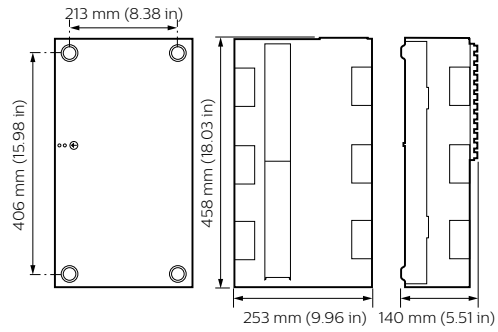

Dynalite Signal Dimmer Controllers

