



Dynalite Signal Dimmer Controllers

DMBC110

Signal Dimmer & Relay Controller (luminaire based)

Signal Dimmer & Relay Controller (luminaire based)

Product data

General Information	
CE mark	CE mark
Remarks	Please download the Lighting - Product Data Sheet for more information and ordering options
EU RoHS compliant	Yes
Application Conditions	
Ambient temperature range	0 to +50 °C
Product Data	
Full product code	871016350636400

Order product name	DMBC110
EAN/UPC – product	8710163506364
Order code	50636400
SAP numerator – quantity per pack	1
Numerator – packs per outer box	1
SAP material	913703030009
SAP net weight (piece)	0.700 kg

Dynalite Signal Dimmer Controllers

Dimensional drawing

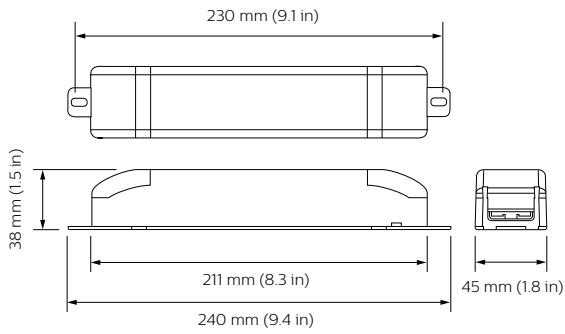

Dynalite Signal Dimmer Controllers

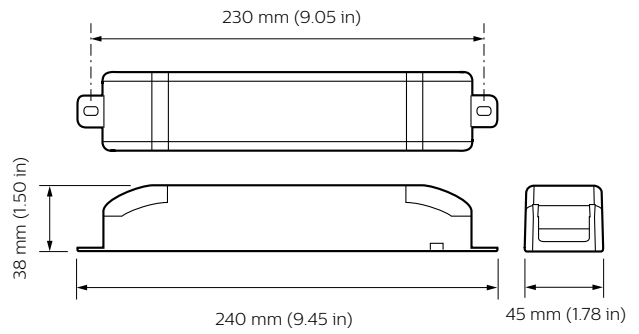

Dynalite Signal Dimmer Controllers

