



Dynalite Leading Edge Dimmers

DDLE802

8 channel Leading Edge Dimmer Controller at 2 A per channel

The Philips Dynalite DDLE802 is an eight channel leading edge dimmer controller with a maximum load per channel of 2 A. - It is suitable for use with incandescent, low voltage, neon and selected fluorescent fixtures. - Optional manual override LED illuminated service switch Soft start and voltage regulation technologies Naturally ventilated Flexible mounting solution

Product data

General Information		Order product name	
CE mark	CE mark	Order product name	DDLE802
Remarks	Please download the Lighting - Product Data Sheet for more information and ordering options	EAN/UPC – product	8710163505008
EU RoHS compliant	Yes	Order code	50500800
		SAP numerator – quantity per pack	1
		Numerator – packs per outer box	1
		SAP material	913703000009
		SAP net weight (piece)	0.600 kg
Application Conditions			
Ambient temperature range	0 to +40 °C		
Product Data			
Full product code	871016350500800		

Dynalite Leading Edge Dimmers

Dimensional drawing

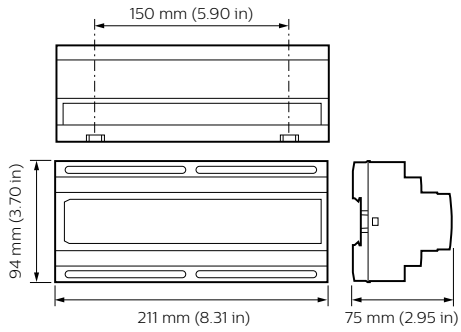

Dynalite Leading Edge Dimmers

