



ClassicStreet

BDP794 LED42-4S/740 II DW10 MK-WH FG BK

ClassicStreet Top - LED module 4200 lm - 740 neutral white - Power supply unit regulating external with constant light output - Safety class II (II) - Distribution wide 10 - Flat glass - Black - Constant light output and DynaDimmer fixed presets version 2 - Surge protection level until 10 kV - External connector - Cable 1.0 m with plug Wieland/Adels compatible 2-pole - Post-top for diameter 60 mm

Recalling the iconic beauty of 20th-century street lanterns, ClassicStreet combines elegant design with the subtle details of heritage luminaires while meeting today's urban lighting requirements. Though echoing the past, the ClassicStreet luminaire is very much shaped for the future. Its gently curved design, together with dedicated brackets and poles, creates a contemporary look that beautifies our cities and creates distinctive and warm night- and daytime ambiances. Not only in historical and traditional architectural settings, but also in more modern urban environments too. Designed around its LED engine, ClassicStreet delivers outstanding levels of lighting and energy performance.

Product data

General Information		Driver/power unit/transformer	Power supply unit regulating external with constant light output
Number of light sources	20 [20 pcs]	Driver included	Yes
Lamp family code	LED42 [LED module 4200 lm]	Optical cover/lens type	FG [Flat glass]
Lamp version	4S [4th generation, screw fixation]	Luminaire light beam spread	52° - 7° x 151°
Light source colour	740 neutral white	Embedded control	CLO-DDF2 [Constant light output and DynaDimmer fixed presets version 2]
Light source replaceable	Yes	Control interface	-
Number of gear units	1 unit		

Connection	CE [External connector]
Cable	Cable 1.0 m with plug Wieland/Adels compatible 2-pole
Protection class IEC	Safety class II (II)
Flammability mark	NO [-]
CE mark	CE mark
ENEC mark	ENEC mark
Warranty period	5 years
Optic type outdoor	Distribution wide 10
Remarks	*- According to the Lighting Europe guidance paper 'Evaluating performance of LED based luminaires – January 2018': statistically there is no relevant difference in lumen maintenance between the B50 and, for example, the B10. Therefore, the median useful life (B50) value also represents the B10 value. * At extreme ambient temperatures the luminaire might automatically dim down to protect components
Constant light output	Yes
Number of products on MCB (16 A type B)	26
Photobiological risk	Photobiological risk group 1 @ 200mm to EN62471
Photobiological risk specification	4 m
EU RoHS compliant	Yes
Light source engine type	LED
Serviceability class	Class B, the luminaire is equipped with some serviceable parts (when applicable): driver, control units, surge-protection device, front cover and mechanical parts
Product family code	BDP794 [ClassicStreet Top]

Light Technical

Upward light output ratio	0.03
Standard tilt angle post-top	-
Standard tilt angle side entry	-

Operating and Electrical

Input Voltage	220-240 V
Input frequency	50 to 60 Hz
Initial CLO power consumption	25 W
Average CLO power consumption	25.5 W
End CLO power consumption	26 W
Inrush current	21 A
Inrush time	0.225 ms
Power factor (min.)	0.97

Controls and Dimming

Dimmable	No
----------	----

Mechanical and Housing

Housing material	Aluminum
Reflector material	-
Optic material	Polymethyl methacrylate
Optical cover/lens material	Glass
Fixation material	Aluminium
Mounting device	60P [Post-top for diameter 60 mm]
Optical cover/lens shape	Flat
Optical cover/lens finish	Clear
Overall length	428 mm
Overall width	428 mm
Overall height	586 mm
Effective projected area	0.15 m ²
Colour	Black
Dimensions (height x width x depth)	586 x 428 x 428 mm (23.1 x 16.9 x 16.9 in)

Approval and Application

Ingress protection code	IP66 [Dust penetration-protected, jet-proof]
Mech. impact protection code	IK09 [10 J]
Surge protection (common/differential)	Surge protection level until 10 kV

Initial Performance (IEC Compliant)

Initial luminous flux (system flux)	2993 lm
Luminous flux tolerance	+/-7%
Initial LED luminaire efficacy	120 lm/W
Init. Corr. Colour Temperature	4000 K
Init. Colour rendering index	70
Initial chromaticity	(0.380, 0.380) SDCM <5
Initial input power	25 W
Power consumption tolerance	+/-11%
Init. colour rendering index tolerance	+/-2

Over Time Performance (IEC Compliant)

Control gear failure rate at median useful life 100,000 h	10 %
Lumen maintenance at median useful life* 100,000 h	L100

Application Conditions

Ambient temperature range	-40 to +50 °C
Performance ambient temperature Tq	25 °C
Maximum dimming level	Not applicable

Product Data

Full product code	871869911688000
Order product name	BDP794 LED42-4S/740 II DW10 MK-WH FG BK
EAN/UPC – product	8718699116880
Order code	11688000
SAP numerator – quantity per pack	1
Numerator – packs per outer box	1
SAP material	912300023858

SAP net weight (piece) 10.000 kg

IP 66 IK 09

Dimensional drawing

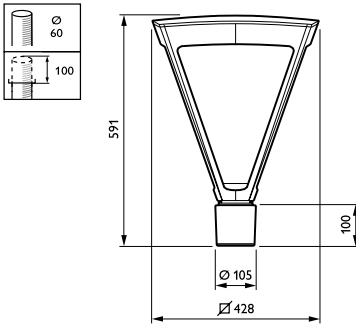

ClassicStreet BDP/BPP/BSP/BVP794

Photometric data

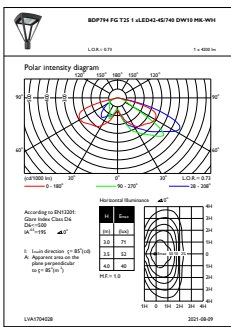

OFPL1_BDP794FGT251xLED42-4S740DW10MK-WH

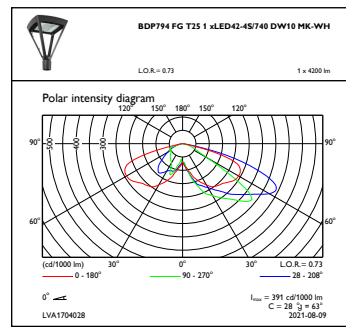

OFPC1_BDP794FGT251xLED42-4S740DW10MK-WH

