



TownGuide Performer

BDP102 LED30/830 DW PCF SI CLO 62P

TOWNGUIDE PERF CLASSIC CONE - LED module 3000 lm -
Distribution wide - Polycarbonate bowl/cover frosted -
Constant light output - Post-top for diameter 62 mm

The TownGuide Performer family consists of six recognizable yet modern shapes: Flat Cone, Bowl, Classic Cone, Classic, T and Tzero. All are available with a clear bowl. Except for Tzero, also a frosted bowl can be chosen. With an extensive range of lumen packages and a choice of light colors and operating lifetimes, it is easy to select the version that best suits your project's specific requirements. In addition, TownGuide Performer has a variety of control system options that can make it an integral part of your smart energy-reduction programs – from stand-alone LumiStep and DynaDimmer, SDU switch-dim control, through to seamless remote connectivity with CityTouch lighting management software. Installation is easy. Thanks to the bayonet whistle connector with integrated gland located in the spigot, the luminaire does not have to be opened at all for installation. Philips has made every effort to make the Total Cost of Ownership (TCO) of the luminaire as attractive as possible. And as TownGuide Performer is a dedicated LED luminaire, compatible with a variety of control systems, the energy and maintenance cost savings compared to conventional lighting are significant.

Product data

General Information			
Number of light sources	4 [4 pcs]	Driver/power unit/transformer	PSR-CLO [Power supply unit regulating with constant light output]
Lamp family code	LED30 [LED module 3000 lm]	Driver included	Yes
Light source colour	830 warm white	Optical cover/lens type	PCF [Polycarbonate bowl/cover frosted]
Light source replaceable	Yes	Luminaire light beam spread	50° x 70°
Number of gear units	1 unit	Embedded control	CLO [Constant light output]
		Control interface	-

TownGuide Performer

Light regulation	-
Connection	Screw connection block 5-pole
Cable	-
Protection class IEC	Safety class I (I)
Parts colour	All parts colored
Coating	-
Glow-wire test	650/5 [Temperature 650 °C, duration 5 s]
Flammability mark	NO [-]
Safety device	PCBC [PCB cover]
CE mark	CE mark
ENEC mark	ENEC mark
Warranty period	5 years
Optic type outdoor	Distribution wide
Photocell	No [-]
Constant light output	Yes
Number of products on MCB (16 A type B)	20
EU RoHS compliant	Yes
WEEE mark	-
Light source engine type	LED
Serviceability class	Class A, the luminaire is equipped with serviceable parts (when applicable): LED board, driver, control units, surge-protection device, optics, front cover and mechanical parts
Product family code	BDP102 [TOWNGUIDE PERF CLASSIC CONE]

Light Technical

Upward light output ratio	10
Standard tilt angle post-top	0°
Standard tilt angle side entry	-

Operating and Electrical

Input Voltage	220-240 V
Input frequency	50 to 60 Hz
Initial CLO power consumption	22.5 W
Average CLO power consumption	23 W
End CLO power consumption	23.5 W
Inrush current	22 A
Inrush time	0.29 ms
Power factor (min.)	0.97
Power factor (nom.)	0.93

Controls and Dimming

Dimmable	No
----------	----

Mechanical and Housing

Housing material	Aluminum
Reflector material	-
Optic material	Acrylate
Optical cover/lens material	Polycarbonate
Fixation material	Steel

Mounting device	62P [Post-top for diameter 62 mm]
Optical cover/lens shape	Conical
Optical cover/lens finish	Frosted
Torque	15
Overall height	317 mm
Overall diameter	570 mm
Effective projected area	0.088 m²
Colour	Silver
Dimensions (height x width x depth)	317 x NaN x NaN mm (12.5 x NaN x NaN in)

Approval and Application

Ingress protection code	IP66 [Dust penetration-protected, jet-proof]
Mech. impact protection code	IK10 [20 J vandal-resistant]
Surge protection (common/differential)	Luminaire surge protection level up to 6 kV differential mode and 6 kV common mode

Initial Performance (IEC Compliant)

Initial luminous flux (system flux)	1740 lm
Luminous flux tolerance	+/-7%
Initial LED luminaire efficacy	77 lm/W
Init. Corr. Colour Temperature	3000 K
Init. Colour rendering index	80
Initial chromaticity	(0.43, 0.40) SDCM <5
Initial input power	23.5 W
Power consumption tolerance	+/-10%
Init. colour rendering index tolerance	+/-2

Over Time Performance (IEC Compliant)

Control gear failure rate at median useful life 100,000 h	10 %
Lumen maintenance at median useful life* 100,000 h	96

Application Conditions

Ambient temperature range	-40 to +35 °C
Performance ambient temperature Tq	25 °C
Maximum dimming level	Not applicable

Product Data

Full product code	871829191068800
Order product name	BDP102 LED30/830 DW PCF SI CLO 62P
EAN/UPC – product	8718291910688
Order code	91068800
SAP numerator – quantity per pack	1
Numerator – packs per outer box	1
SAP material	910500991129
SAP net weight (piece)	6.500 kg



TownGuide Performer

Dimensional drawing

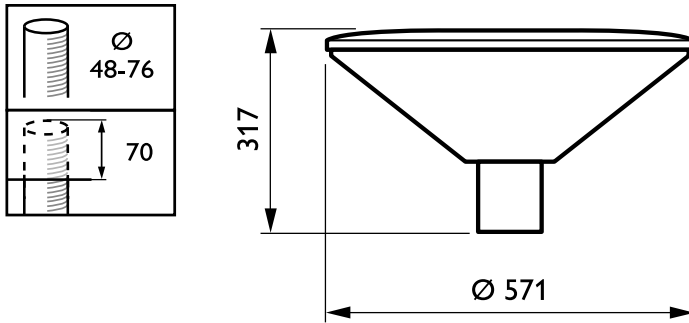

TownGuide Performer BDP100-105

