

Long-lasting, reliable solution

HID-HeavyDuty BSN semi-parallel for SON/CDO/MH/HPI

Encapsulated electromagnetic copper/iron ballasts for use with an external semi-parallel ignitor for CDM, CDO, MH, HPI (Plus) and SON lamps

Benefits

- Excellent resistance to chemical impact, humid conditions and environmental stress crack
- Long-lasting reliable solution – outstanding product lifetime of 15 years average
- Minimal watt losses thanks to orthocyclic winding process
- Control gear can be installed remotely

Features

- Encapsulated with thermoplastic polyester resin, reinforced with glass fiber
- Equipped with screw terminal blocks as standard; insert contacts available upon request
- Ballasts for alternative mains voltages/frequencies available upon request
- Separate earth terminal (HID 'Heavy Duty')

Application

- Outdoor lighting (most popular application: road and tunnel lighting)

HID-HeavyDuty BSN semi-parallel for SON/CDO/MH/HPI

Versions

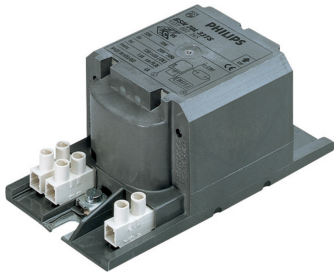

Dimensional drawing

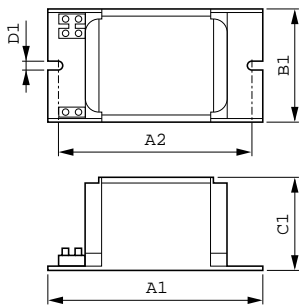

Product	D1	C1	A1	A2	B1
BSN 70 L34-A2-TS 240V 50Hz HD1-118	6.2 mm	53.0 mm	118.0 mm	103.0 mm	65.0 mm
BSN 400 L33-A2-TS 230V 50Hz HD3-166	6.2 mm	84.0 mm	166.0 mm	147.5 mm	102.0 mm

Operating and Electrical

Input Frequency 50 Hz

General Information

Number Of Lamps 1 piece/unit

Operating and Electrical

Order Code	Full Product Name	Input Voltage
05970331	BSN 70 L34-TS 240V 50Hz HD1-118	240 V

Order Code	Full Product Name	Input Voltage
05976530	BSN 400 L33-TS 230V 50Hz HD3-166	230 V

General Information

Order Code	Full Product Name	Lamp Type
05970331	BSN 70 L34-TS 240V 50Hz HD1-118	SON/CDO

Order Code	Full Product Name	Lamp Type
05976530	BSN 400 L33-TS 230V 50Hz HD3-166	SON/HPI

System characteristics

Order Code	Full Product Name	Rated Ballast-Lamp Power
05970331	BSN 70 L34-TS 240V 50Hz HD1-118	70 W

Order Code	Full Product Name	Rated Ballast-Lamp Power
05976530	BSN 400 L33-TS 230V 50Hz HD3-166	400 W

HID-HeavyDuty BSN semi-parallel for SON/CDO/MH/HPI

